

Portable Gas Conditioning Unit Series PSS®

PSS5C, PSS5C/2, PSS5C/3

Instruction Manual

Version 1.02.13



**Dear customer,**

Thank you for buying our product. In this manual you will find all necessary information about this M&C product. The information in the manual is fast and easy to find, so you can start using your M&C product right after you have read the manual.

If you have any question regarding the product or the application, please don't hesitate to contact M&C or your M&C authorized distributor. You will find all the addresses in the appendix of this instruction manual.

For additional information about our products, please go to M&C's website www.mc-techgroup.com. There you can find the data sheets and manuals of our products in German and English.

This instruction manual does not claim completeness and may be subject to technical modifications.

© 05/2021 **M&C Techgroup** Germany GmbH. Reproduction of this document or its content is not allowed without permission from **M&C**.

PSS® is a registered trade mark.

Version: 1.02.13

List of Contents

1	General information	5
2	Declaration of conformity	5
3	Safety instructions	6
4	Warranty	6
5	Used terms and signal indications	7
5.1	Type plate and labels on the device	8
6	Introduction	10
7	Function of the M&C Jet-Stream Heat Exchanger	10
8	Application	11
9	Technical data	13
10	Dimensions	19
11	Description	20
12	Operating instructions	23
12.1	Main Menu.....	23
12.2	PIN Entry.....	24
12.3	Set Point Entry.....	25
13	Parameter Setting	26
13.1	Setting Temperature Alarm Limits.....	27
13.2	Fan Speed Setting.....	28
13.3	Brightness Setting of Display	28
14	mA Output for the Temperature Measurement inside the Cooling Block	29
14.1	mA Output Range Selection	29
14.2	mA Output Calibration for the Temperature Measurement inside the Cooling Block.....	29
15	Liquid Alarm Sensor (LA) type LA1S	31
15.1	Activating the LA.....	31
15.2	LA Sensitivity adjustment.....	32
15.3	LA Calibration	33
16	Receipt of goods and storage	34
17	Installation instructions	35
17.1	Liquid alarm sensor with switch-off function for sample gas pump.....	35
18	Supply connections	36
18.1	Tube connections.....	36
18.1.1	Connecting the heated sample line with special adapter (option).....	38
18.2	Electrical connections	38
19	Commissioning	41
20	Closing down	42
21	Maintenance	43
22	Alarm and Error Messages	44
23	Trouble shooting	45
24	Proper disposal of the device	46
25	Spare parts list	47
26	Appendix	49

List of Figures

Figure 1	Type plate.....	8
Figure 2	Labelling of the connections.....	8
Figure 3	Warning label on the device.....	9
Figure 4	Diagram of the heat exchanger function.....	10
Figure 5	Gas flow diagram of PSS5C and PSS5C/3.....	11
Figure 6	Gas flow diagram of PSS5C/2.....	12
Figure 7	Dimensions.....	19
Figure 8	Case content: PSS5C and PSS5C/3.....	20
Figure 9	Navigating through the main menu.....	23
Figure 10	Reaching the set point entry from the ECP1000C/ECP3000C main menu.....	25
Figure 11	Temperature alarm limits and hysteresis.....	27
Figure 12	LA alarm limits.....	32
Figure 13	PSS5C and PSS5C/3 medium connections.....	36
Figure 14	Connecting the heated sample line with special adapter (option).....	38
Figure 15	Electrical connection.....	39
Figure 16	Circuit diagram PSS5C.....	50

HEAD OFFICE

M&C TechGroup Germany GmbH ♦ Rehhecke 79 ♦ 40885 Ratingen ♦ Germany
Telephone: 02102 / 935 – 0
Fax: 02102 / 935 – 111
E - mail: info@mc-techgroup.com
www.mc-techgroup.com

1 General information

The product described in this instruction manual has been built and tested in our production facility.

All M&C products are packed to be shipped safely. To ensure the safe operation and to maintain the safe condition, all instructions and regulations stated in this instruction manual need to be followed. This instruction manual includes all information regarding proper transportation, storage, installation, operation and maintenance of this product by qualified personnel.

Follow all instructions and warnings closely.

Read this manual carefully before commissioning and operating the device. If you have any questions regarding the product or the application, please don't hesitate to contact M&C or your M&C authorized distributor.

2 Declaration of conformity

CE - Certification

The product described in this operating manual complies with the following EU directives:

EMC-Instruction

The requirements of the EU directive 2014/30/EU "Electromagnetic compatibility" are met.

Low Voltage Directive

The requirement of the EU directive 2014/35/EU "Low Voltage Directive" are met.
The compliance with this EU directive has been examined according to DIN EN 61010.

RoHS Directive

The requirements of the RoHS2 ('Restriction of Hazardous Substances 2') directive 2011/65/EU and its annexes are met.

Declaration of conformity

The EU Declaration of conformity can be downloaded from the **M&C** homepage or directly requested from **M&C**.

3 Safety instructions

Follow these basic safety procedures when mounting, starting up or operating this equipment:

Read this instruction manual before starting up and use of the equipment. The information and warnings given in this instruction manual must be heeded.

Any work on electrical equipment is only to be carried out by trained specialists as per the regulations currently in force.

The installation and commissioning of the device must conform to the requirements of VDE 0100 (IEC 364) 'Regulations on the Installation of Power Circuits with Nominal Voltages below 1000 V' and must be in compliance with all relevant regulations and standards.

Check the details on the type plate to ensure that the equipment is connected to the correct mains voltage.

Protection against touching dangerously high electrical voltages:

Before opening the equipment, it must be switched off and hold no voltages. This also applies to any external control circuits that are connected.

The device is only to be used within the permitted range of temperatures and pressures.

Ensure sun-protected installation.

The unit may only be operated upright and with the door closed. Unused connectors must be closed with the appropriate caps. IP42 means protection against foreign objects ≥ 1 mm and dripping water up to an angle of $\leq 15^\circ$.

Do not use the gas conditioning systems PSS5C, PSS5C/2 and PSS5C/3 in hazardous areas.

Installation, maintenance, inspections and any repairs of the devices must be carried out only by qualified skilled personnel in compliance with the current regulations.

4 Warranty

In case of a device failure, please contact immediately M&C or your M&C authorized distributor.

We have a warranty period of 12 months from the delivery date. The warranty covers only appropriately used products and does not cover the consumable parts. Please find the complete warranty conditions in our terms and conditions.

The warranty includes a free-of-charge repair in our production facility or the free replacement of the device. If you return a device to M&C, please be sure that it is properly packaged and shipped with protective packaging. The repaired or replaced device will be shipped free of delivery charges to the point of use.

5 Used terms and signal indications



DANGER

This means that death, severe physical injuries and/or important material damages **will occur** in case the respective safety measures are not fulfilled.



WARNING

This means that death, severe physical injuries and/or important material damages **may occur** in case the respective safety measures are not fulfilled.



CAUTION

This means that minor physical injuries **may occur** in case the respective safety measures are not fulfilled.

CAUTION

Without the warning triangle means that a material damage may **occur** in case the respective safety measures are not met.

ATTENTION

This means that an unintentional situation or an unintentional status **may occur** in case the respective note is not respected.



NOTE

These are important information about the product or parts of the operating manual which require user's attention.

QUALIFIED PERSONNEL

These are persons with necessary qualification who are familiar with installation, use and maintenance of the product.



High voltages!

Protect yourself and others against damages which might be caused by high voltages.



Corrosive!

These substances destroy living tissue and equipment upon contact.

Do not breathe vapors; avoid contact with skin and eyes.



Wear protective gloves!

Working with chemicals, sharp objects or extremely high temperatures requires wearing protective gloves.



Wear safety glasses!

Protect your eyes while working with chemicals or sharp objects. Wear safety glasses to avoid getting something in your eyes.



Wear protective clothes!
Working with chemicals, sharp objects or extremely high temperatures requires wearing protective clothes.

5.1 Type plate and labels on the device

A type plate, an information label and a warning label are located on the device.

The type plate contains the product name, the serial number including explanation, electrical connection data and the manufacturer's address.

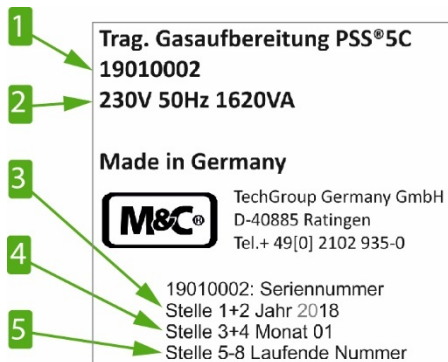

1 Serial number

2 Electrical connection data

3 S/N: digits 1+2: Year 2018

4 S/N: digits 3+4: Month 01

5 S/N digits 5 to 8: consecutive number

Figure 1 Type plate

The position of the electrical connections and gas connections are explained on the label below the connections on the case side.

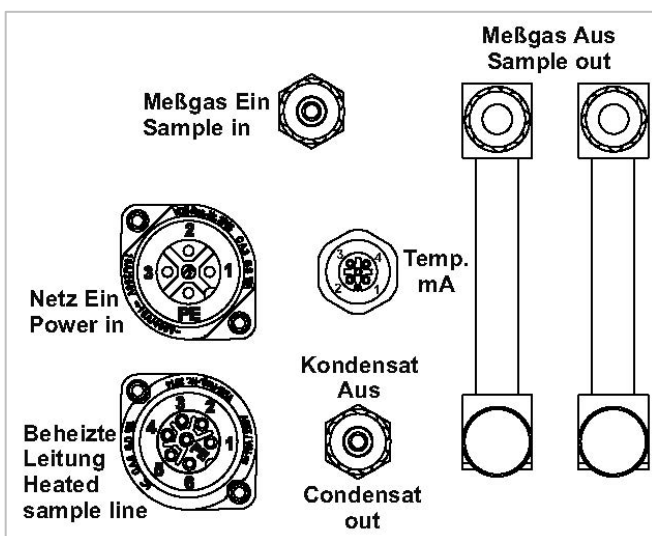

Figure 2 Labelling of the connections

The warning label indicates the necessary requirements for operating the device.

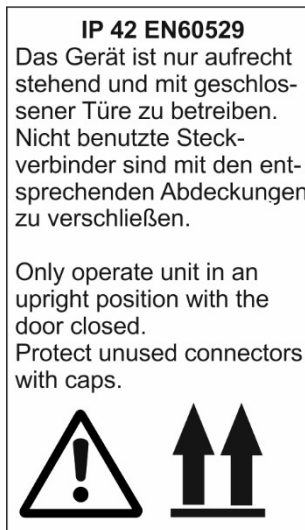

Figure 3 Warning label on the device

6 Introduction

The portable gas conditioning systems **PSS5C**, **PSS5C/2** and **PSS5C/3** are designed especially for applications where accurate gas analysis at constantly changing locations is required.

The entire gas conditioning system is housed in a compact and impact-resistant plastic case equipped with an integrated trolley with extendable handle. This allows gas analysis at various locations to be carried out quickly, reliably and with low maintenance.

7 Function of the M&C Jet-Stream Heat Exchanger

The **ECPX000C** gas coolers, specially developed for analysis technology, are designed for maximum flow rates of up to 350 NI/h. They are also installed as system assemblies in the PSS5C, PSS5C/2 and PSS5C/3.

Jet-Stream heat exchangers are available in Duran glass, stainless steel (316Ti) and PVDF (polyvinylidene fluoride). The selection of the appropriate heat exchanger material is customer-specific. The heat exchangers are easily accessible and easily replaceable in a heat-insulated cooling block. Figure 4 shows a schematic diagram of the heat exchanger function.

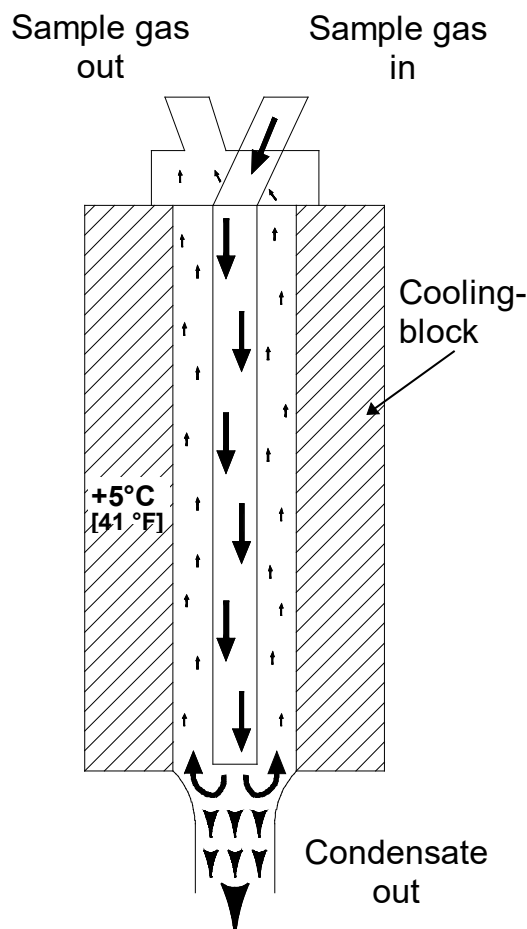
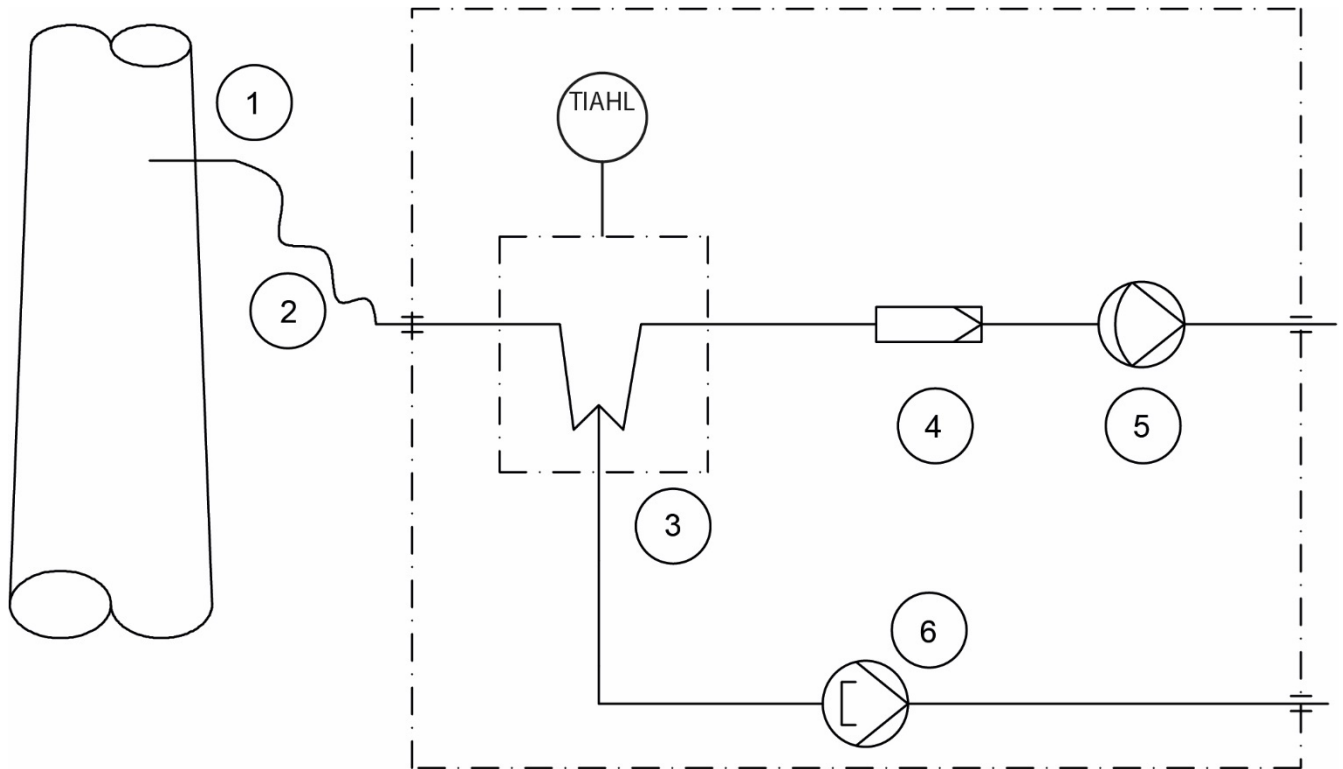

Figure 4 Diagram of the heat exchanger function

8 Application

The PSS5C gas conditioning system is suitable for variable discontinuous use as well as for continuous operation. The upright, closed PSS5C case with screwed in connectors complies with protection class IP42 as required by the EN15267-4:2017 standard. It contains a standard gas temperature monitoring as well as a temperature display visible from the outside.



- ① Gas sample probe made of SS316Ti, Ø 4/6 mm, length 0.5 m
- ② Gas sample line, PVC tube, Ø 4/6 mm, length 3 m
- ③ Peltier gas cooler with temperature alarm high/low (TIAHL)
- ④ Fine filter **FP-2T**, filter element porosity 2 µm
- ⑤ Sample gas pump **N3 KPE** (options: N5 KPE (Part No. 01G9090), N9 KPE (Part No. 01G9095))
- ⑥ Peristaltic pump **SR25.2-W** for continuous condensate removal

Figure 5 Gas flow diagram of PSS5C and PSS5C/3

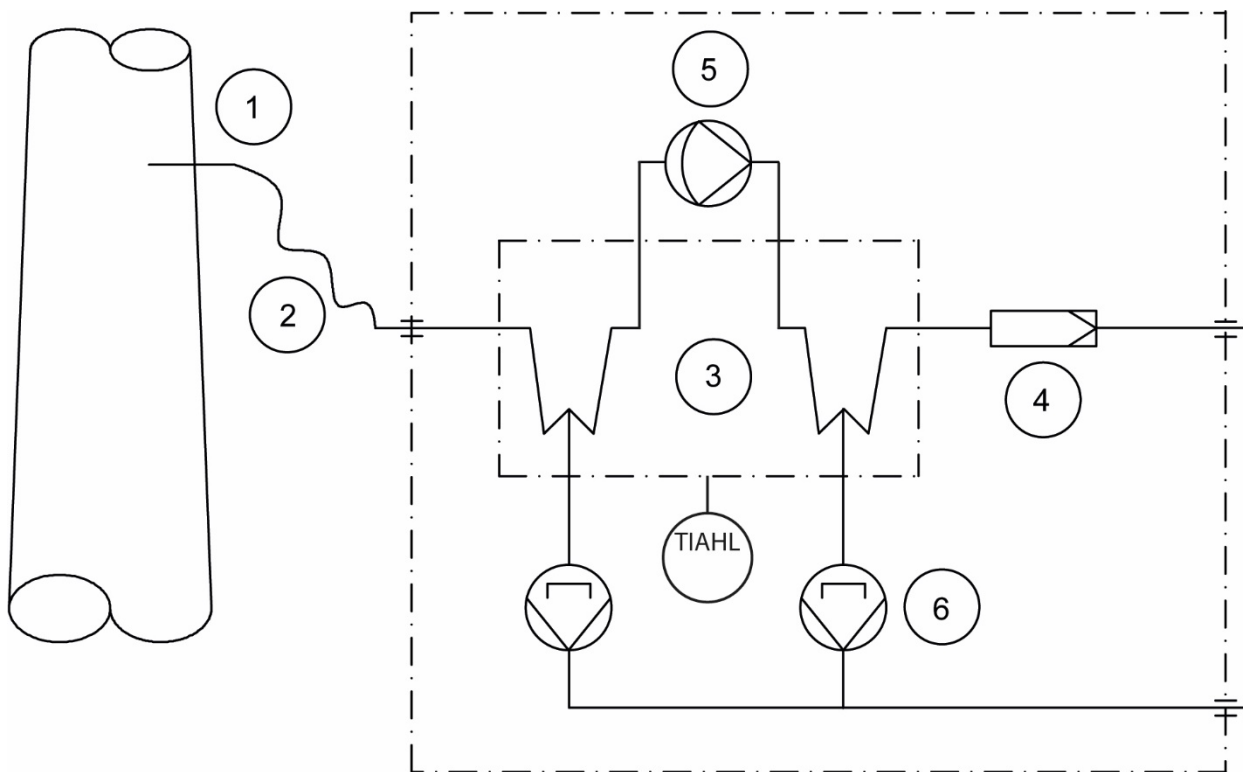

- ① Gas sample probe made of SS316Ti, \varnothing 4/6 mm, length 0.5 m
- ② Gas sample line, PVC tube, \varnothing 4/6 mm, length 3 m
- ③ Peltier gas cooler with temperature alarm high/low (TIAHL)
- ④ Fine filter **FP-2T**, filter element porosity 2 μ m
- ⑤ Sample gas pump **N3 KPE** (options: N5 KPE (Part No. 01G9090), N9 KPE (Part No. 01G9095))
- ⑥ Peristaltic pump 2 x **SR25.2-W** for continuous condensate removal

Figure 6 Gas flow diagram of PSS5C/2

9 Technical data

Gas Conditioning Type	PSS5C	PSS5C/2	PSS5C/3
Part No.	01G4000	01G4250	01G4500
Sample gas outlet dew point	Range of adjustment: +2 to 15 °C [35.6 to 59 °F], factory setting: +5 °C [41 °F]		
Sample gas outlet dew point stability	At const. conditions: < ±0.1°C [±0.18 °F]		
Sample gas inlet temperature	*Max. 80°C [176 °F], optional: *max. 180°C [356 °F] with stainless steel bulkhead union		
Sample gas inlet water vapor saturation	*Max. +80 °C [176 °F]		
Heat exchanger gas flow rate	*Max. 150 NI/h	*Max. 150 NI/h per heat exchanger	*Max. 350 NI/h
Ambient temperature	*5 to 40 °C [41 to 104 °F]		
Storage temperature	-25 to +65 °C [-13 to +149 °F]		
Pressure	0.7 bar to 1.4 bar abs.		
Total cooling power*	Max. 80 kJ/h		
Number of gas inlets	1		
Number of gas outlets	1, optional: max. 2		
Medium connections	Tube connections 4/6 mm, material: PVDF		
Material of parts beeing in contact with the medium	Stainless steel, glass, PVDF, PTFE, Novoprene*		
Ready for operation	Approx. 3 min. (with heated line approx. 1 h)		
Mains power supply	230 V AC ±10 % 50/60 Hz or 115 V AC ±10 % 60 Hz		
Power consumption	Max. 240 VA; with option temperature controller and heated sample line: 230 V, max. 1620 VA; 115 V, max. 920 VA		
Fuse protection	4 A t, 5 mm x 20 mm; with option temperature controller: 10 A t, 5 mm x 20 mm		
Electrical connection	2 m [≈ 6.56 ft] length cable		
Electrical equipment standard	EN 61010		
Case protection	IP42 EN 60529, with upright case and door closed. Unused connectors must be closed with appropriate caps.		
Housing	Portable impact-resistant case with integrated trolley system and pull-out handle		
Housing color	Black		
Housing dimensions (W x H x D)	451 x 654 x 279 mm [≈ 17.8" x 25.7" x 11"] with casters and handle		
Weight w/o options	Approx. 18.5 kg [≈ 40.8 lbs]	Approx. 19.7 kg [≈ 43.4 lbs]	Approx. 18.9 kg [≈ 41.7 lbs]

PTFE=Polytetrafluoroethylene (Teflon®), PVDF=Polyvinylidenfluoride

* Maximum values in technical data must be rated in consideration of total cooling capacity at 25 °C [77 °F] ambient temperature and an outlet dew point of 5 °C [41 °F].

Options	Type	Part No.
Sample tube	Sample tube out of Kanthal® ø 6 mm, length: 1 m, sampling temperature: max. 1300 °C [2372 °F]	01G9030
Electronic temperature controller for max. 12 m [39.4 ft] heated sample line 100 W/m	701 control range: 0 to 200 °C [32 to 392 °F], inlet PT100, power: 230 V/50 Hz, contact capacity: 250 V AC max. 10 A, completely mounted incl. 7-pin plug 10 A	01G9055
Electronic temperature controller for max. 6 m [19.7 ft] heated sample line 100 W/m	701 control range 0 to 200 °C [32 to 392 °F], inlet PT100, power: 115 V/60 Hz, contact capacity: 250 V AC max. 10 A, completely mounted incl. 7-pin plug 10 A	01G9055a
Temperature controller 701, Ni-CrNi, 230 V	Temperature controller 701 for thermocouple, rail-mount enclosure, control range: 0 to 200 °C, contact rating: 10 A/250 V, power: 230 V 50/60 Hz	01B8245
Temperature controller 701, Ni-CrNi, 115 V	Temperature controller 701 for thermocouple, rail-mount enclosure, control range: 0 to 200 °C, contact rating: 10 A/250 V, power: 115 V 50/60 Hz	01B8245a
Connecting adapter DN 4/6 for heated sample line	PSS5C connecting adapter with anti-kink protection for rigid mounting of heated sample line with replaceable PTFE tube DN 4/6, consisting of special Swagelok fitting with 4 mm support sleeve, material: SS316Ti	01G9060
Connecting adapter DN 6/8 for heated sample line	PSS5C connecting adapter with anti-kink protection for rigid mounting of heated sample line with replaceable PTFE tube DN 6/8, consisting of special Swagelok fitting with 6 mm support sleeve, material: SS316Ti	01G9061
Sample gas pump N5 KPE, replacement	Extra charge for replacing the standard N3 KPE by the N5 KPE	01G9090
Sample gas pump N9 KPE, replacement	Extra charge for replacing the standard N3 KPE by the N9 KPE	01G9095

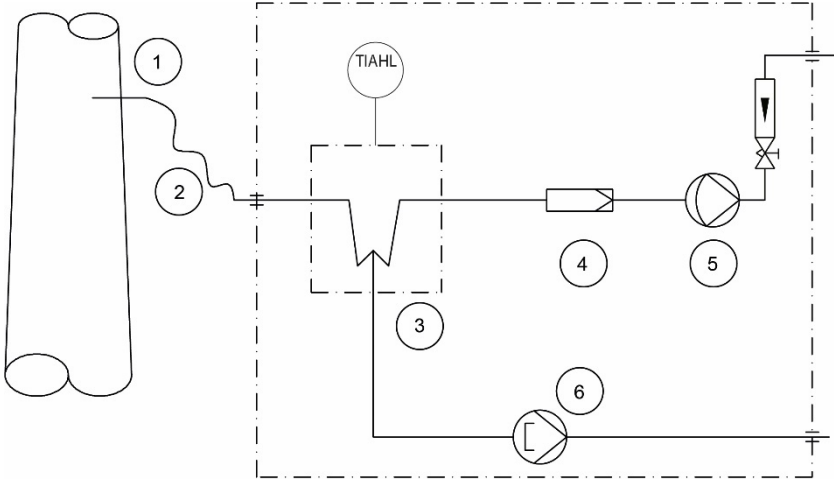
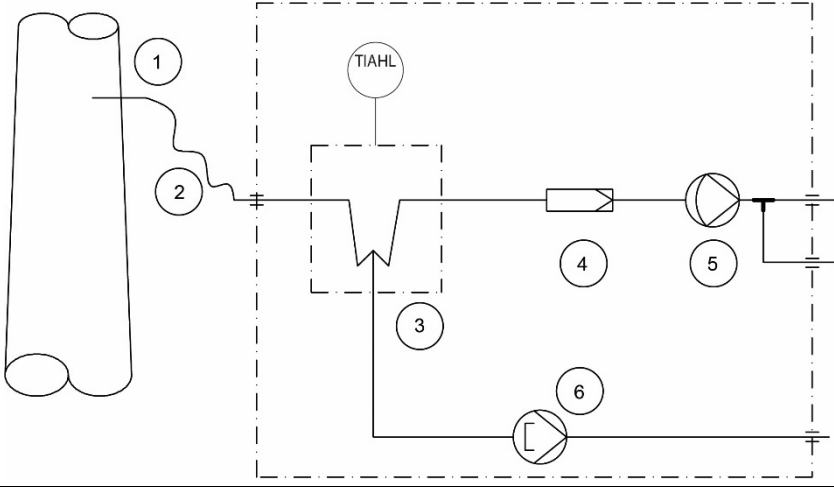
Options	Type	Part No.
Flow meter including sample gas outlet, max. 2 pieces	FM40 7-70 NI/h air FM40 15-150 NI/h air FM40 25-250 NI/h air FM40 50-500 NI/h air 	01G9072 01G9077 01G9082 01G9087
Further sample gas outlet w/o flow meter	Parallel sample gas outlet, tubing via T-piece on lateral PVDF bulkhead fitting, DN 4/6, max. 1 piece 	01G9065
3-way ball valve (Note: only one FM40 flow meter is possible with this version)	3L/PV-1 for switching over from test gas to sample gas, in the inlet of the sample gas conditioning unit, mounted with mounting bracket, fittings in PVDF	01G9046

Options	Type	Part No.
<p>5-way ball valve (Note: only one FM40 flow meter is possible with this version)</p>		<p>01G9045</p>
<p>Needle valve</p>		<p>01G9050</p>

Options	Type	Part No.
Analog output	<p>Analog output of the sample gas cooler temperature at the PSS5C case with connection socket, mA output for PSS5C 0/4 to 20 mA, galvanically isolated, burden: 500 Ohm</p>	01G9010
mA output	<p>Thermocouple type K for temperature measurement in heat exchanger with output 4-20 mA for -10 to 50 °C [14 to 122 °F], load 100 Ohm</p>	01K9250
Liquid alarm sensor LA1S	<p>Liquid alarm detection inside the PSS5C case incl. switch-off function for sample gas pump, liquid sensor type LA1S with cable break detection, for conductive media, completely wired, evaluation via front display</p>	01G9015

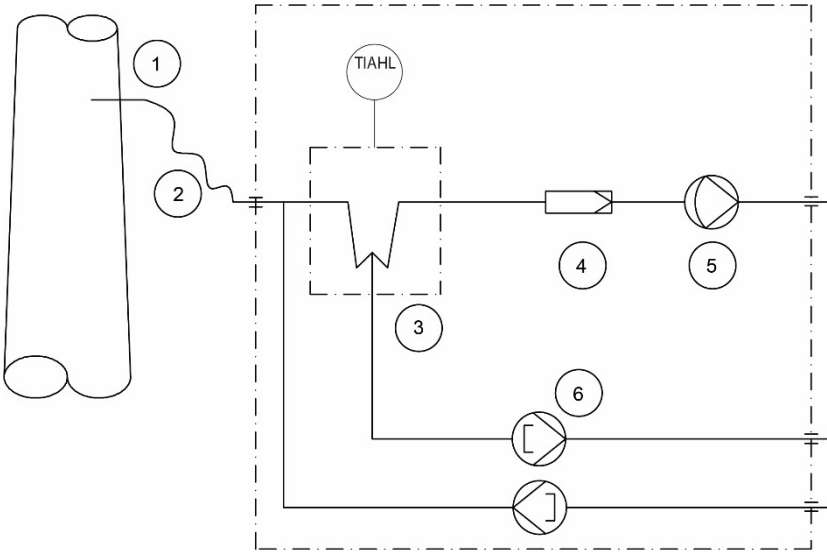
Options	Type	Part No.
SR25.3-W (Note: only one FM40 flow meter is possible with this version)	For acid dosing by an additional peristaltic pump. 	01P1320
Sample gas inlet made of stainless steel	Extra charge for portable gas conditioning unit type PSS/SS with stainless steel fittings in the sample gas inlet for 6 mm tube, material: SS316Ti	C40002
Built-in aerosol filter CLF-5	Extra charge for portable gas conditioning unit type PSS/SS with built-in aerosol filter CLF-5, fittings and mounting included	C40003
Sample gas outlet made of stainless steel	Extra charge for portable gas conditioning unit type PSS/SS with stainless steel fittings in the sample gas outlet for 6 mm tube, material: SS316Ti	C40005
Shoulder strap for mounting on the PSS-5C case	Padded and adjustable shoulder strap made of robust polyester for material for mounting on the PSS5C case.	90G0270

Other versions on request.

10 Dimensions

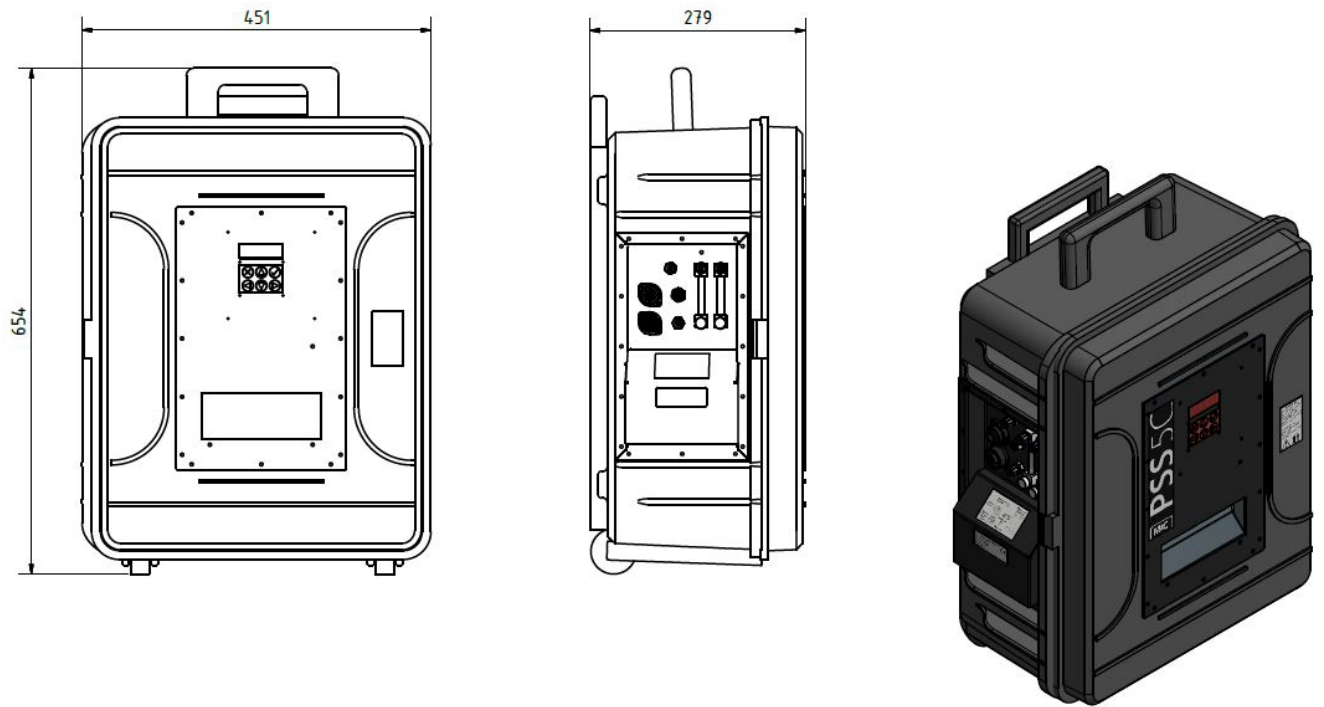

Figure 7 Dimensions

11 Description

The PSS5C gas conditioning system is equipped with the powerful Peltier gas cooler of the new series as standard.

The cooler is equipped with a jet-stream heat exchanger, which cools the sample gas constantly to +5 °C [41 °F], independent of the ambient temperature. As soon as the operating temperature < +8 °C [46.4 °F] is reached after commissioning, the sample gas pump N...KPE is automatically switched on by the gas cooler status contact. The peristaltic pump SR 25.2-W ensures continuous condensate removal. This also allows to easily accomplish long-term measurements with the gas conditioning system. The corresponding particle filtration is carried out by the FP-2T fine filter.

For easy handling of the PSS5C, the display and function of the cooler are visible from the outside. The case only needs to be opened for maintenance.

The portable PSS5C gas conditioning system is a complete conditioning system for most gas analysis devices. The components installed in the PSS5C are intended for "continuous use". For special measuring tasks, additional or other components from our extensive product range can also be used.

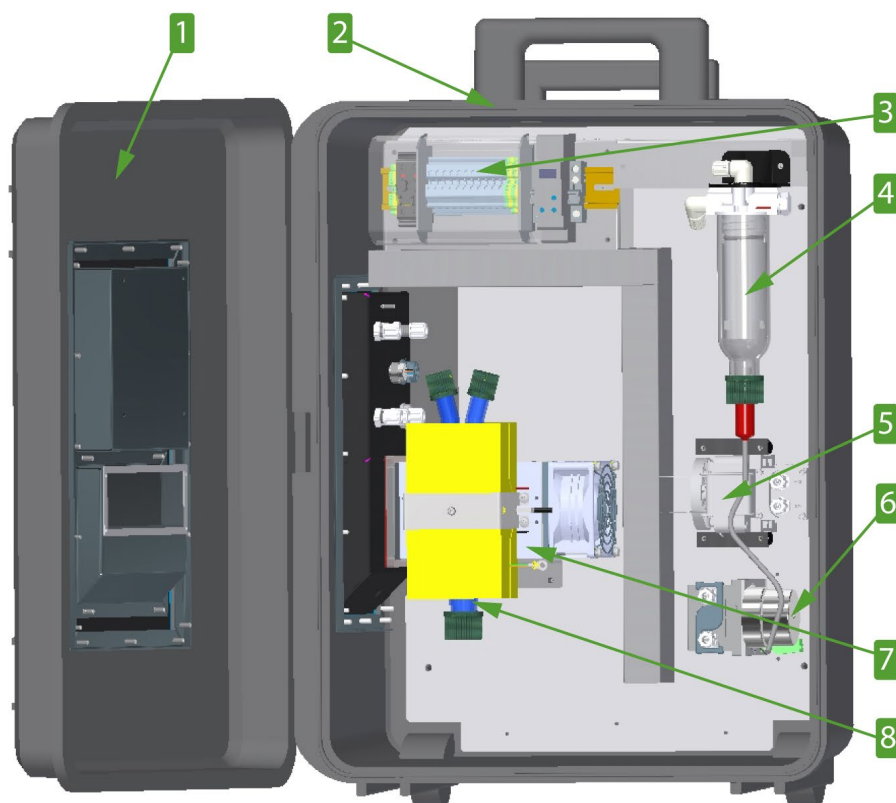

- 1 Case door with display
- 2 Case
- 3 Terminal mounting rail
- 4 Fine filter FP-2T

- 5 Sample gas pump
- 6 Peristaltic pump
- 7 Gas cooler
- 8 Heat exchanger

Figure 8 Case content: PSS5C and PSS5C/3

All components of the gas conditioning system are freely accessible and built into a portable case **2**. The case door **1** can be opened to the left by loosening the latches mounted on the side and top of the case.

The installation of the gas cooler **7** and a corresponding diaphragm sample gas pump **5** depends on the required maximum gas volume flow.

The minimum flow rate is determined by the sample gas pump **5**. If the required minimum total flow rate is not reached, excessive overpressure can lead to premature destruction of the pump diaphragm. The maximum pressure is reduced by using an optional needle valve in the bypass of the sample gas pump (Part No. 01G9050).

The gas cooler is equipped with a Duran glass heat exchanger **8** as standard. Heat exchangers in PVDF or stainless steel are optionally available.

The **FP-2T** fine filter (2 µm filter porosity) **4**, installed upstream of the sample gas pump **5**, ensures the necessary solids separation.

The overtemperature alarm contact (+8 °C [46.4 °F]) of the cooler automatically regulates the switching on and off of the sample gas pump **5**.

The resulting condensate is continuously discharged by a peristaltic pump type **SR25.2-W** **6**.

The 4/6 mm tube connections for the condensate and sample gas lines are located on the side of the case.

A stainless steel sample probe (length 0.5 m, Ø 6 mm) and a 3 m PVC sample tube (4/6 mm) are included in the standard scope of delivery.

The ventilation grids in the door and in the left side wall of the case provide sufficient convex forced ventilation.

Options:

The **PSS5C...** sample gas conditioning unit can be equipped at the factory with a maximum of two sample gas outlets. Each sample gas outlet can be controlled by the optional installation of a flow meter type **FM40** with needle valve according to the specified volume flow range (see the option table in chapter '9 Technical data'). Unused mounting holes for sample gas outlets or flow meters are closed with blind caps.

I To protect the downstream analyzers against liquid ingress and to increase the operational reliability of the entire system, we recommend the installation of a liquid alarm sensor type **LA1S** with cable break detection (Part No. 01G9015). For this purpose, the **FP-2T** fine filter installed as standard is replaced by the **FP-2T-D** fine filter with mounted liquid alarm sensor at the factory. The evaluation electronics for the **LA1S** liquid sensor are integrated as standard in the ECPX000C cooler.



The **PSS5C...** can also be equipped with a special sample gas inlet (Part No. 01G9060) for connecting a heated line. The existing kink protection can only be used for heated lines with connection type "C" (Part No. 03B1020). Assembly instructions can be found in chapter "18.1.1 Connecting the heated sample line with special adapter (option)".

It is also possible to connect the heated line (Part No. 01B4036) in connection with the gas sampling probe **PSP 4000**.

The temperature controller **701** (Part No. 01G9055) which is necessary for the regulation of the heated line is mounted on the terminal rail **3** (Figure 8) at the factory with the required option.

A 3-way ball valve (Part No. 01G9046) or a 5-way ball valve (Part No. 01G9045) can optionally be installed in the inlet of the gas conditioning unit for test gas feeding or sample gas switching.

12 Operating instructions

The display and control panel of the ECPX000C are clearly visible on the front panel of the PSS5C case. The functions described here are excerpts from the operating instructions of the ECPX000C series. For the complete documentation, read the ECPX000C instruction manual. It can be downloaded free of charge from the M&C homepage.





NOTE

The complete instruction manual of the ECPX000C can be found at www.mc-techgroup.com.

In the main menu, the cooler temperature, the ambient temperature, the set absolute or differential set point and the current set point can be displayed. The set point entry and the menu for parameter setting can be accessed via a PIN entry. PIN entry prevents unintentional adjustment of the set point and the device configuration.



Use the arrow keys to navigate through the menu and enter values. Press the "OK" key  to confirm entries and the "Exit" key  to exit the input area or to reject an entry.

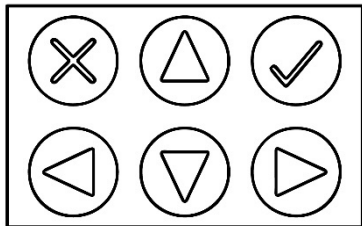

12.1 Main Menu

After approx. 3 minutes the device is ready for operation. The current cooler temperature is displayed first. Use the arrow keys to navigate through the main menu. The following figure shows an example of how you can navigate through the main menu.



Figure 9 Navigating through the main menu



NOTE

Tap on the -key, to go back to the cooling temperature.

The cooling temperature is shown in the display as follows:



The cooler temperature is shown on the display.



The ambient temperature is indicated by a "0" sign on the left side of the displayed temperature.



The set point for absolute value control is indicated by an "A" and the set point for differential control by a small "d" before the temperature value.



The absolute value control temperature can be set between 2 to 15 °C [35.6 to 59 °F]. The differential value control temperature can be set between dT = 2 to 15 °C [dT = 3.6 to 27 °F].



The display of the current signal value is indicated by a capital "P" on the right-hand side. The signal value is a measure for the percentage workload. The signal value can assume values from 0 to 99.



NOTE

You will find the complete menu structure in the appendix of the ECPX000C instruction manual.



12.2 PIN Entry

To enter the range of set point input or parameter setting, a PIN must be entered. The PIN "1234" is factory-set and cannot be changed.

To enter the PIN, proceed as follows:



Press and hold the -key until "0000" appears in the display.

The "0" on the left side is blinking. Use the  and -keys to enter the first digit of the PIN.

Use the  and -keys to switch to the other digits. If a digit is blinking, the PIN digit can be entered.



The PIN "1234" looks like this on the display.





Confirm the PIN with the -key.

After confirmation, immediately the display for the set point entry is shown. Press and hold the -key longer to access the parameter setting area.

The PIN is valid for 15 minutes. If you exceed this time, the display field reappears with "0000" when you press and hold the -key. The PIN must be entered there again.



12.3 Set Point Entry

If you tap the -key briefly after entering the PIN (see chapter "12.2 PIN Entry"), the set point for the cooler temperature appears. This set point can belong to the operating mode "absolute control" ("A") or "differential control" ("d").

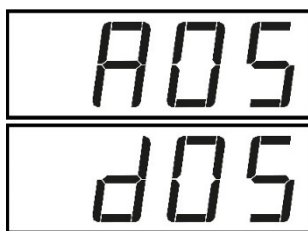
The two digits start blinking. The absolute value control temperature can be set from 2 to 15 °C [35.6 to 59 °F] using the  and -keys. The differential value control temperature can be set from dT = 2 to 15 °C [dT = 3.6 to 27 °F] using the  and -keys. The factory setting is absolute value control temperature of 5 °C [41 °C].



Use the  and -keys to switch between the operating mode and set point settings.

If the letter on the left side is blinking, you can use the  and -keys to switch between absolute and differential value control of the set point temperature.



NOTE

Tap the -key, then the entries are discarded and you return to the cooler temperature.

As long as the PIN is active (see chapter "12.2 PIN Entry"), the set point entry can also be accessed from the main menu. To change a set point, press the -key for 2 seconds during the current temperature or set point display. The display then changes to set point input. The two digits start blinking. Values can be set here. The following figure shows, using the example of an ECP1000C/ECP3000C, how to access the set point input from the main menu.

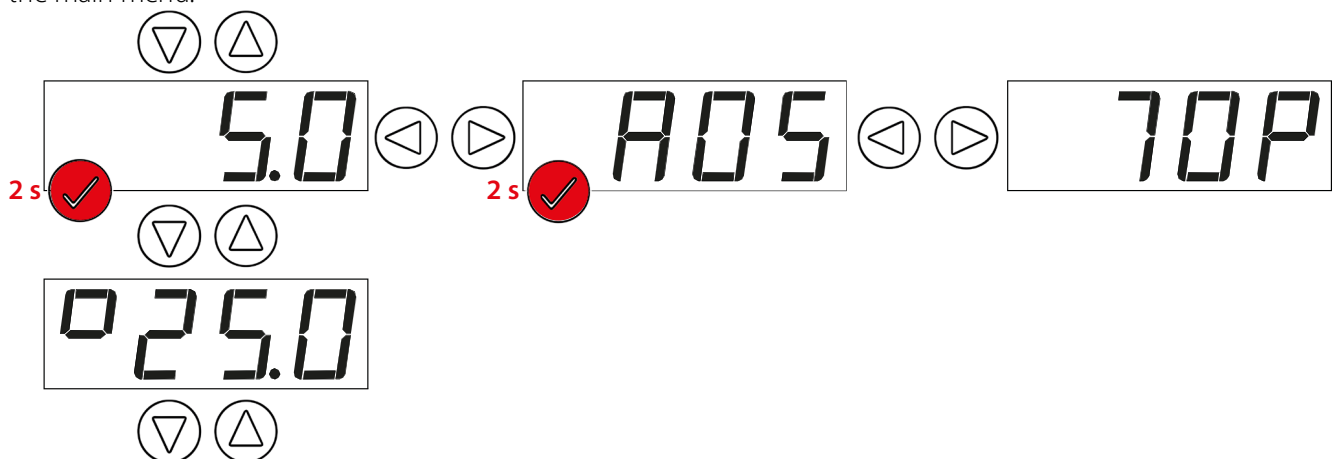





Figure 10 Reaching the set point entry from the ECP1000C/ECP3000C main menu

13 Parameter Setting

If you tap the -key after entering the PIN (see chapter "12.2 PIN Entry"), the set point for the cooler temperature appears first. If the -key is pressed and held for a short moment, the display changes to code entry. Here you can enter the codes that belong to the respective parameter settings.

You can also access the parameter setting from the main menu. To do this, keep the -key pressed until the code entry is displayed. The PIN must be active in this case.







NOTE

The codes for parameter settings can be found in the appendix of this instruction manual.



To adjust the device parameters, the code belonging to the parameter must be entered and confirmed in this display. The left digit of the code entry is blinking. The first digit can be entered here.

Use the  and -keys to switch between the digits and the  and -keys to set the individual digits.

A code can have up to 3 digits. Single-digit codes are device-specific, two-digit codes are important basic settings (tens digit corresponds to the channel number), three-digit codes are used for calibration (hundreds digit: "2" stands for LA, "3" for mA calibration).

The PIN is valid for 15 minutes. If you exceed this time, the display field reappears with "0000" when you press and hold the -key. The PIN must be entered there again (see chapter "12.2 PIN Entry").

If you enter an invalid code and press the -key, the display returns to the cooler temperature.

13.1 Setting Temperature Alarm Limits

You use the temperature alarm limits to determine when the alarm is triggered. HIGH dT and LOW dT are independently adjustable from $dT = 2$ to $8\text{ }^{\circ}\text{C}$ [$dT = 3.6$ to $14.4\text{ }^{\circ}\text{F}$]. In the following figure, the upper temperature alarm limit is set at $8\text{ }^{\circ}\text{C}$ [$46.4\text{ }^{\circ}\text{F}$] and the lower one at $3\text{ }^{\circ}\text{C}$ [$37.4\text{ }^{\circ}\text{F}$].

The hysteresis is set to "1".

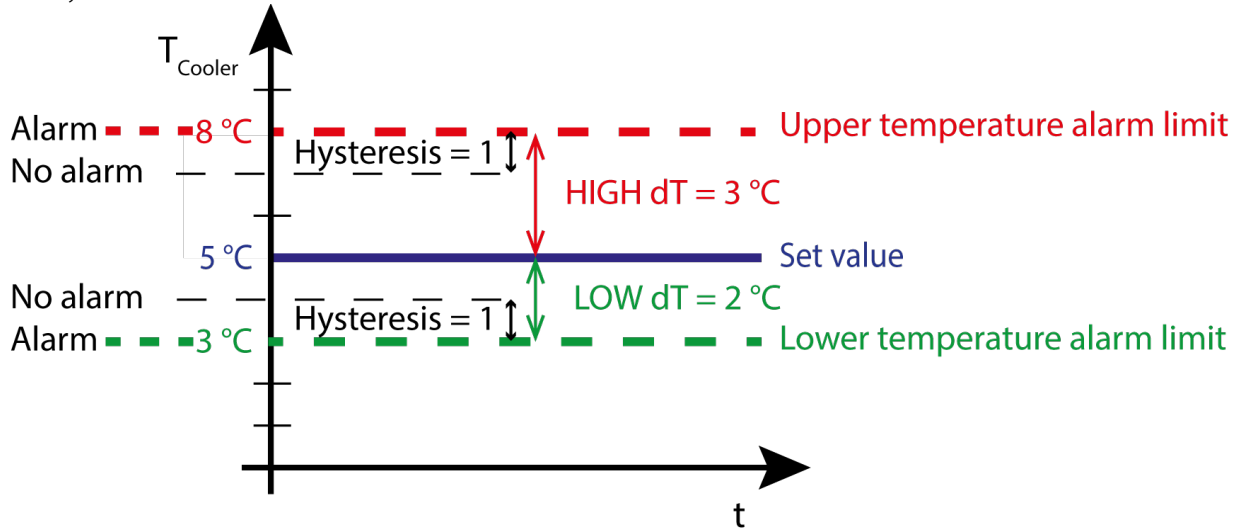



Figure 11 Temperature alarm limits and hysteresis



To set the temperature limits:



1. Enter the PIN (see chapter "12.2 PIN Entry").
2. Tap and hold the -key for a short moment.
3. The display shows the code entry.



The code for setting HIGH dT of the channel is "012". Confirm the code with the -key, then the display of the pre-set value appears.



After confirming the code, the default value "3" appears. The value is blinking and you can enter values from $dT = 2$ to $8\text{ }^{\circ}\text{C}$ [$dT = 3.6$ to $14.4\text{ }^{\circ}\text{F}$] with the  and -keys.

Press  to confirm your change or  to leave the code range without making any changes. After changing or aborting the display shows the cooler temperature again.

The code for setting LOW dT is "013". If you enter this code, you can change the lower temperature alarm limit.

The hysteresis setting can be changed via code "014". The hysteresis ensures that no "fluttering" occurs in the event of a temperature alarm. The differential value $dT = 1$ or $2\text{ }^{\circ}\text{C}$ [1.8 or $3.6\text{ }^{\circ}\text{F}$] can be entered.



NOTE

If HIGH dT or LOW dT is reduced to "2", the hysteresis is automatically reduced to the differential value $dT = 1\text{ }^{\circ}\text{C}$ [$1.8\text{ }^{\circ}\text{F}$].

13.2 Fan Speed Setting

The ECPX000C is equipped with a large cooling fin block which is forced-ventilated by a fan. The minimum speed of the fan can be changed without affecting the final performance of the cooler.

To change the fan speed setting:

1. Enter the PIN (see chapter "12.2 PIN Entry").
2. Tap and hold the -key for a short moment.
3. The display shows the code entry.
4. The code for setting the fan speed is "084". The setting range is between 0 and 5. At level 0 the fan rotates slower and is quieter. At higher values, the fan rotates faster and the air flow rate is increased.

Level 2 is set by default This fan speed is necessary to reduce the temperature increase inside the case.

13.3 Brightness Setting of Display

It may be necessary to change the brightness of the display due to different lighting conditions at the locations where the cooler is used. The brightness of the display can be adjusted on the control panel of the ECPX000C.

To change the brightness setting:

1. Enter the PIN (see chapter "12.2 PIN Entry").
2. Tap and hold the -key for a short moment.
3. The display shows the code entry.



You can also enter the code from the main menu. To do this, keep the -key pressed until the code entry is displayed. The PIN must be active in this case.





Enter the code "005" and confirm the code with the -key.



Now the default brightness value appears. The factory setting is "5".

This value is blinking and can be set between "0" and "9" with the  and -keys. The brightness of the digits changes immediately. The lower the value, the darker the display.

Select the desired brightness value and confirm the selection with the -key or cancel the procedure with the key. Use the -key to leave the range of codes without making any changes.

After changing the brightness or canceling, the display shows the cooler temperature again.

14 mA Output for the Temperature Measurement inside the Cooling Block

The mA outputs built-in by M&C are factory calibrated and set to the range "4-20 mA". Later purchased mA outputs must be calibrated.

14.1 mA Output Range Selection



The optional mA output can be changed from 4-20 mA to 0-20 mA. To select the mA range, proceed as follows:

1. Enter the PIN (see chapter "12.2 PIN Entry").
2. Tap and hold the -key for a short moment.
3. The display shows the code entry.





Enter the code "015". Confirm the code with the -key, then the display of the preset range appears.



The default value "4-20", which stands for 4 to 20 mA, appears on the display. The whole display is blinking here. Use the  and -keys to switch between "4-20" and "0-20".



Press  to confirm your change or  to leave the code range without making any changes. After changing or aborting the display shows the cooler temperature again.

14.2 mA Output Calibration for the Temperature Measurement inside the Cooling Block

The mA output built-in by M&C are factory calibrated. If required, the basic accuracy of the mA output can be optimized by recalibration.

A later installed mA output must be calibrated. The mA output is suitable for a maximum load of 500 Ω only. During calibration, first the lower and then the upper value of the mA output will be calibrated.



NOTE

If the mA output is ordered when ordering the instrument, the mA output is calibrated at the factory. If a mA output is purchased by the customer and retrofitted by the customer, the calibration must be carried out by the customer.

Optionally, the device can be sent to M&C for retrofitting.

The mA output is set to 4 - 20 mA as standard, but can be changed to 0 - 20 mA on the instrument. In both cases the mA range corresponds to the temperature range -10 °C to +50 °C [14 to 122 °F].

Current limitation:

The current output limits in the case of 4 - 20 mA in the lower range to 3.8 mA and in the upper range to 20.5 mA. In the case of 0 - 20 mA, it limits the upper range to 20.5 mA.



NOTE

If a calibration error occurs and the mA output has been calibrated, the limiting values also change!

To calibrate an mA output, proceed as follows:

1. Enter the PIN (see chapter "12.2 PIN Entry").
2. Tap and hold the -key for a short moment.
3. The display shows the code entry.



Enter the code "310" for the calibration of the lower value of the mA output. Now connect a current meter to the connector of the mA output. This current meter should measure a value close to 1 mA. You can now adjust this value in 0.0054 mA steps with the up and down arrow keys. After the adjustment, the current meter should display 1 mA as accurately as possible. Accept the value with the -key.



Enter the code "C311" for the calibration of the upper value of the mA output. Now connect a current meter to the connector of the mA output. This current meter should be used to measure a value close to 20 mA. You can now adjust this value in 0.0054 mA steps with the up and down arrow keys until the current meter displays 20 mA as accurately as possible. Accept the value with the -key.

The cooler should then be in a steady state at 5 °C [41 °F] (absolute value control) and provide one of the following values:

- 8 mA (in case of 4 - 20 mA)
- 5 mA (in case of 0 - 20 mA)

The cable length is not limited, and the cable does not need to be shielded.

15 Liquid Alarm Sensor (LA) type LA1S

M&C installs the liquid alarm sensors type LA1S with cable break detection. They are factory calibrated to tap water and activated with cable break detection. Later purchased liquid alarm sensors must be activated and calibrated.

15.1 Activating the LA

A retrofit liquid alarm sensor LA1S must be activated. The LA1S can be activated with or without cable break detection.

To activate a liquid alarm sensor:

1. Enter the PIN (see chapter "12.2 PIN Entry").
2. Tap and hold the -key for a short moment.
3. The display shows the code entry.



The code for activation is "010".

Confirm the code with the -key.



You can choose between the values "0", "1" and "2". With "1" you activate the sensor without cable break detection, with "2" you activate the sensor with cable break detection. With "0" the sensor is deactivated accordingly.

After activating the LA1S, the sensor needs to be calibrated.

15.2 LA Sensitivity adjustment

The sensitivity can be changed by following these steps:

1. Enter the PIN (see chapter "12.2 PIN Entry").
2. Tap and hold the -key for a short moment.
3. The display shows the code entry.



Enter the code "011" to change the sensitivity of the liquid sensor.

The default value is 2 and can be changed from 1 to 7. The sensitivity corresponds to the switching threshold for the alarm and is to be understood as follows:

Sensor state	Sensitivity	Electrical conductivity
Dry	0 %	
7	30 %	$\approx 50 \mu\text{S/cm}$
6	40 %	
5	50 %	
4	60 %	
3	70 %	
2	80 % (Standard)	$\approx 300 \mu\text{S/cm}$
1	90 %	
Wet	100 %	

The cancellation limit is always 15 % below the sensitivity limit. If the sensitivity value of 2 is not changed, the alarm is triggered at 80 % and is automatically cancelled as soon as it falls below 65 %.

The following diagram illustrates the correlations:

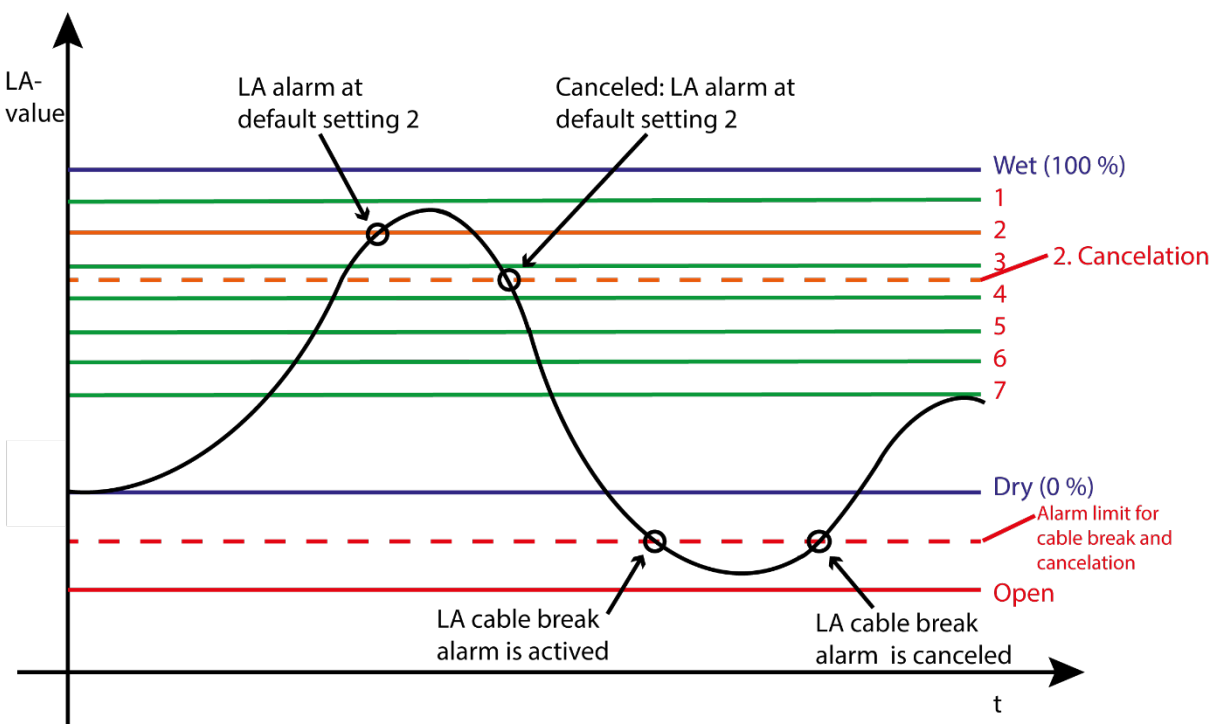

Figure 12 LA alarm limits

15.3 LA Calibration

The liquid alarm sensors LA1S with cable break detection installed by M&C are factory activated and calibrated. If required, the basic accuracy of the liquid alarm sensors can be optimized by recalibration. Later-installed liquid sensors must be activated and calibrated.



NOTE

Make sure that the LA is activated. If a retrofitted LA1S is not activated, the calibration has no effect and will be discarded.

To calibrate a liquid alarm sensor, proceed as follows:

1. Enter the PIN (see chapter "12.2 PIN Entry").
2. Tap and hold the -key for a short moment.
3. The display shows the code entry.



First calibrate the "dry state" of the liquid alarm sensor.

To do this, leave the LA in the dry state and enter the code "210". Confirm the displayed value with the -key.



Then calibrate the "wet state" of the liquid alarm sensor.

Immerse the LA in the process-dependent condensate to calibrate the 100 % wet condition via code "211". Confirm the displayed value with the -key.

16 Receipt of goods and storage

The gas conditioning and sampling systems **PSS5C**, **PSS5/2** and **PSS5C/3** are completely pre-installed units.

The sample tube, gas sample hose, connecting cable and instruction manual are located inside the case door.

- Immediately after arrival take the gas conditioning system and possible special accessories carefully out of the packaging material.
- Compare the goods with the items listed on the delivery note.
- Check the goods for any damage caused during delivery and, if necessary, notify your transport insurance company without delay of any damage discovered.



NOTE

The gas conditioning unit should be stored in a protected frost-free area!

17 Installation instructions



NOTE

The case should be placed on a level, horizontal surface so that it is secure and stable.

The operating position is exclusively upright. This is the only way to ensure proper separation and removal of the condensate in the cooler's heat exchanger.

The gas conditioning unit should be installed away from heat sources and freely ventilated so that no disturbing heat accumulation occurs

For outdoor installation, adequate protection against direct sunlight and moisture must be provided. In winter, the installation site must be frost-free; observe the protection class of the case.

The device must only be operated upright and with the door closed. Unused connectors must be closed with the appropriate covers. IP42 means protection against foreign bodies ≥ 1 mm and dripping water up to an angle of $\leq 15^\circ$.

In order to ensure the operational safety of the portable gas conditioning system and the downstream analyzers and to avoid false alarms, the sample gas conditioning system must not be used outside the specified temperature range.

Downstream analyzers must always be operated at temperatures well above the specified gas output dew point of $+5^\circ\text{C}$ [41°F]. The temperature of the sample gas must not exceed the specified temperature range. This avoids subsequent condensation of the gas in the connecting lines to the analyzers.

Unheated gas sampling lines must be routed with a downward gradient to the cooler. Condensate pre-separation is then not necessary.

17.1 Liquid alarm sensor with switch-off function for sample gas pump



NOTE

Check the sensitivity setting of the LA1S to ensure that it is suitable for the condensate used. Check if the liquid alarm sensor triggers reliably.

A sensitivity of 80 % and an electrical conductivity of approx. $300 \mu\text{S}/\text{cm}$ are set at the factory.

For adjusting the LA sensitivity, see chapter 15.2.

18 Supply connections

18.1 Tube connections



NOTE

**Do not switch tube connections; connections are marked accordingly.
After all lines have been connected, the tightness must be checked.**

Figure 13 shows the possible medium connections. These are located in the right-hand side of the gas conditioning case at the rear in a specially immersed assembly frame.

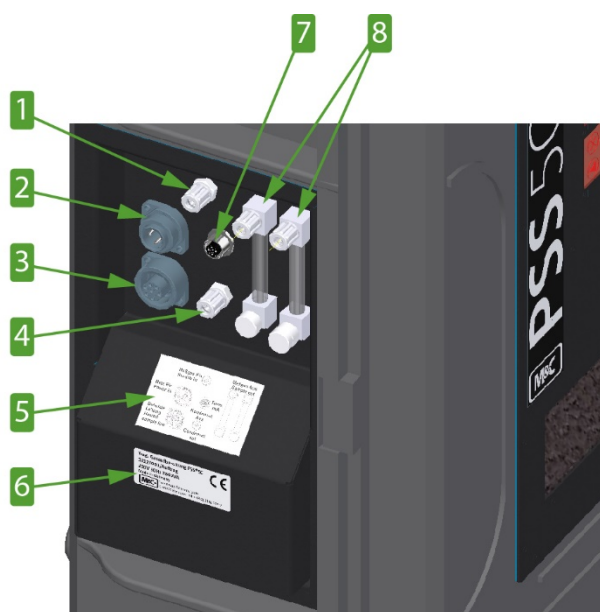

1 Sample gas IN

2 Power supply

3 Heated sample line connection

4 Condensate outlet

5 Connections description

6 Type plate

7 mA-output (temperature)

8 Flow meter(s) with sample gas OUT

Figure 13 PSS5C and PSS5C/3 medium connections

All tube connections are equipped with 4/6 mm clamping ring tube fittings made of polyvinylidene fluoride (PVDF) for gas inlet temperatures of up to a maximum of 80 °C [176 °F] (see chapter '9 Technical data'). When heated sample lines are used, the gas inlet temperatures can increase up to a maximum of 180 °C [356 °F]. In this case, the use of optional stainless steel bulkhead fittings is recommended.

Connecting tubes of dimension 4/6 mm are used as standard.

Install the sample gas tubes and the condensate tube as follows:

1. Remove the union nut from the clamping ring tube fittings by turning it anti-clockwise. The nut should be removed from the thread with great care so as to ensure that the loose sealing ring in the nut is not lost.
2. Place the union nut over the connecting tube.
3. Place the sealing ring over the connecting tube with the thicker bead towards the nut.
4. Place the tube over the nipple on the thread.

**NOTE**

The tightness of the connections can only be guaranteed if the connecting tube has a straight rim (hose cutter).

5. Tighten the union nut hand-tight.

The tube will no longer be able to slip off and is now compression-proof.

Disassemble the tubes in reverse order.

**WARNING**

Aggressive condensate possible.



Wear protective glasses and proper protective clothing!



18.1.1 Connecting the heated sample line with special adapter (option)

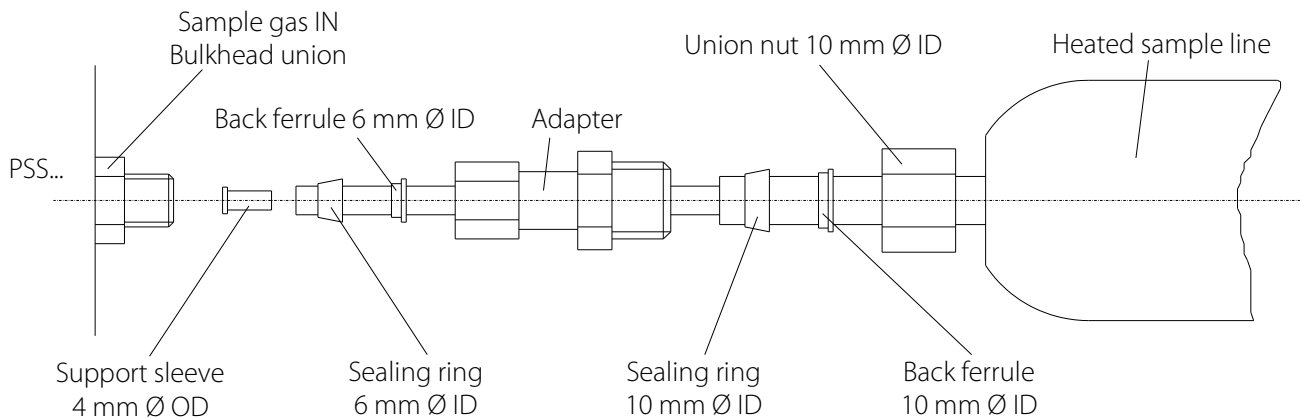

Figure 14 Connecting the heated sample line with special adapter (option)

The heated line is connected to the gas conditioning with the connection adapter (Part No. 01G9060) as follows:

1. Place the special adapter (Part No. 01G9060) on the PTFE tube according to the drawing seen above;
2. Place the support sleeve into the PTFE tube;
3. Insert the PTFE tube as far as it will go into the 'Sample Gas IN' bulkhead fitting and hand-tighten the adapter;
4. Tighten the adapter 1 1/4 turns with a wrench (SW 14), while holding the lock nut of the bulkhead connection with a wrench (SW 15);
5. Insert the 10 mm tube of the heating line into the adapter as far as it will go and hand-tighten it with the union nut;
6. Tighten union nut with wrench (SW 19) 1 1/4 turns; hold adapter with wrench against;

The screw connection is now cut gas-tight and can be loosened as often as required.

18.2 Electrical connections



WARNING

Wrong supply voltage can damage the equipment. When connecting the equipment, make sure that the supply voltage is identical with the information provided on the model type plate!



NOTE

For the erection of power installations with rated voltages up to 1000 V, the requirements of VDE 0100 and relevant standards and specifications must be observed!

The main circuit is equipped with a fuse corresponding to the nominal current (over current protection); for electrical details see technical data.

The **PSS5C...** gas conditioning system is available with either 230 V/50 Hz or with 115 V/60 Hz (for circuit diagram see Appendix). The device is protected by a 4 A fuse as standard. The fuse is located on the terminal mounting rail (see Figure 8). In the event that a temperature controller is used in conjunction with heated sample lines, the overload protection level is increased to 10 A.

The power supply connector is a round 4 pole connector (male). The heated sample line connector is a round 7 pole connector (female). The mA-output connector is a round 4 pole signal connector (female). All electrical connectors are located on the left-hand side of the case.

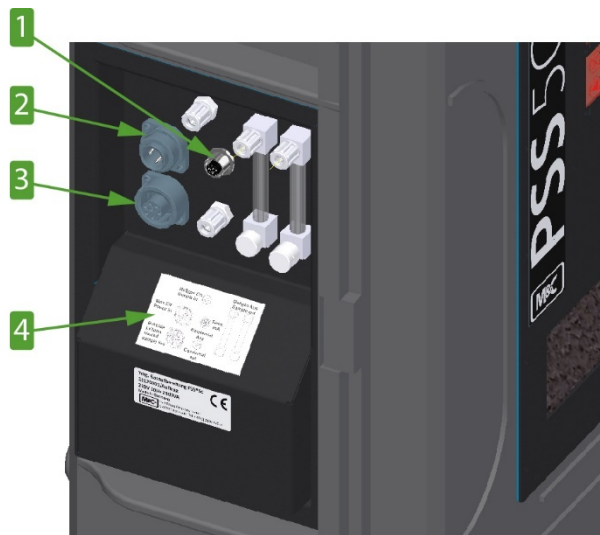

1 mA-output (temperature)
2 Power supply connection

3 Heated sample line connection
4 Connections description

Figure 15 Electrical connection

Option “heated sample line”:

For the electrical supply of a heated line with PT-100 sensor a 7-pin connector **3** is available. For the electrical supply of other heated components (e.g. heated sample gas probe or heated filter) a 4-pole round plug connector is available at the heated lines Part No 01B4050 or 01B4040. The maximum connected load is 6 A, 1380 W for the 230 V sample gas conditioning unit and 6 A, 690 W for the 115 V version.

The maximum length of a possible heated sample line is calculated as follows:

$$L(m) = \frac{\text{Max. connection power [W]} - \text{Power consumption of heated components (i.e. sample probe) [W]}}{\text{Power consumption of heated sample line [W/m]}}$$

Option "mA output; cooling block temperature Part No 01G9010":

The connection of the mA signal output is a 4-pole circular connector (female) .

The mA output signal is available at pin 1 + and 3 -.

Measuring range: -10 to 50 °C [14 to 122 °F], mA output 4 to 20 mA or 0 to 20 mA, factory setting 4-20 mA. To select the mA output range and to calibrate the mA output see chapter 14.1 and 14.2.

The load is 500 Ohm.

Option "mA output; temperature in heat exchanger Part No 01K9250":

The connection of the mA signal output is a 4-pole circular connector (female) .

The output signal is available at pin 2 + and 4 -.

Measuring range -10 to 50 °C [14 to 122 °F], mA output 4 to 20 mA, load 100 Ohm.

The range of the mA output is fixed and can only be changed at the factory.

19 Commissioning

Observe the facility and process-specific safety measures before commissioning.

Carry out the following steps before initial commissioning:

1. Connect the round 4 pole connector (male)  on the device with the supplied mains connection cable.
2. Connect the heated sample line (option).



WARNING

Check the temperature at the temperature controller when operating the sample gas conditioning unit with a heated sample gas line.

3. Connect the mains plug of the supplied mains connection cable to the power supply.
4. Set the desired temperature on the temperature controller.

Type 701:

The digital display of the controller shows the actual value of the heated line after switching on the sample gas conditioning. The controller is factory set to 0 °C [32 °F]. Briefly press the *P* key to change the set point. *SP* appears in the display and then the display changes to the adjusted set point. Use the arrow keys to set the desired value. After 60 seconds, the display automatically changes to the actual value.

Type 701 (effective from: September 2020, Serial No. 2009143):

After switching on, the display of the controller shows the actual value and the setpoint of the heated line. On delivery, the set point is set to 0 °C [32 °F].

To change the set point, press one of the arrow keys to adjust the desired set point.



NOTE

The complete instruction manual of the temperature controller 701 is available at www.mc-techgroup.com.

The gas cooler is ready for operation after approximately 3 minutes. If a heated line is connected, the time in which the gas conditioning unit is ready for operation increases to approx. 1 hour.

The over temperature alarm contact of the cooler switches the sample gas pump automatically on as soon as the temperature reaches +8 °C [46.4 °F].



NOTE

The following minimum gas flow rates result from the requirement of the maximum pressure-side load of the sample gas pumps N3 KPE, N5 KPE and N9-KPE of 1.4 bar abs:

N3 KPE approximately 60 NI/h air.

N5 KPE approximately 100 NI/h air.

N9 KPE approximately 200 NI/h air.

Premature damage can be caused to the pump membrane if less than the minimal total amount of flow is extracted as a result of over pressure.

For long-term measurements with a high dust content in the sample gas, a suitable gas sampling probe must be provided to protect the sample line from being clogged.

20 Closing down



The area where the gas conditioning unit is placed must remain frost-free even when the unit is switched off.

No special measures are to be taken in the event of short-term shutdowns of the gas conditioning system.

In the case of long-term shutdowns, for example after a completed series of measurements, it is recommended to purge the gas conditioning system with fresh air or inert gas. A flushing time of 3 to 5 minutes is sufficient under normal conditions. Condensate residues must also be removed from the system.



Aggressive condensate is possible.



Wear protective glasses and proper protective clothing!

21 Maintenance

Observe the facility- and process-specific safety measures before carrying out maintenance work!



WARNING



Dangerous voltage!

It is necessary to take the equipment off the mains before any assembly, maintenance or repair work is carried out.

The frequency of the maintenance work depends on the operational process and can therefore only be determined in each individual case.

All parts which might require maintenance work are easily accessible housed in the gas conditioning system. The following parts might require maintenance work (see Figure 8):

- Check the filter element of the fine filter **FP-2T** and replace if necessary.



NOTE

In order to protect downstream analyzers, the wet filter element must always be replaced in the event of a condensate breakthrough.

- Check the tube of the **SR25.2-W** condensate pump every six months and replace if necessary;



NOTE

The complete instruction manual of the SR25.2-W is available at www.mc-techgroup.com.

- Check the diaphragm of the gas feed pump **N3 KPE** (optional N5 KPE or N9 KPE) every six months and replace if necessary.;



NOTE

The complete instruction manual of N3 KPE, N5 KPE, N9 KPE is available at www.mc-techgroup.com.

- Check fan grids for contaminations and clean if necessary.

22 Alarm and Error Messages

The PSS5C has several monitoring functions. If an alarm limit is exceeded or not reached or if an error occurs during operation, the corresponding messages are shown on the display. These messages are displayed cyclically and alternate with the current cooler temperatures.

If several alarm or error messages occur simultaneously, the messages are shown on the display one after the other.

The alarm and error messages are listed here:

Display	Description	Action	Clear the alarm/error message
A1	The temperature of stage 1 has exceeded the outer limit of the alarm band	Relay 1 opens	The temperature of stage 1 exceeds the inner limit of the alarm band
LA1	The liquid alarm sensor LA1 has registered a level of humidity corresponding to the set sensitivity	Relay 1 opens	The LA1 must register a dry state 15 % below the trip limit.
E1	The temperature sensor 1 cannot be queried or does not pass the plausibility check several times	Relay 1 opens, Control of the Peltier element is switched off	The measured values can be read again (e.g. after cable examination or sensor replacement)
E3	The temperature sensor 3 cannot be queried or does not pass the plausibility check several times	No effect with absolute value control. With dT control, the corresponding relay opens, and the stage is switched off.	The measured values can be read again (e.g. after cable examination or sensor replacement)
E4	No voltage flanks resulting from a fan rotation are measured	Stage 1 and stage 2 switch off and both relays drop out.	The fan supplies voltage flanks again (e.g. after cable examination or fan replacement)
E5	The temperature of cooling stage 1 exceeds a maximum value of 60 °C [140 °F]	Relay 1 opens, Control of the Peltier element is switched off	Device restart after cooling down

23 Troubleshooting

The following table aims to point out possible operational problems and offer solutions to such problems (not applicable during the starting procedure).

Problem	Display	Possible Causes	Check/Solution
Gas flow interruption	No display	No voltage	Check supply voltage with model type plate; OK? Check if the supply voltage plug is insert correctly; OK? Check the fine fuse on connector block 3 (Figure 8); OK?
	Error code: E5	Cooler does not work; Cooler alarm detects 'over temperature'. Cooler turns sample gas pump off automatically.	Ambient temperature too high. OK? Free convection in case impaired ⇒ case temperature too high; OK? Cooler error (see instruction manual ECPX000C); ok?
Cooler works, but gas flow is interrupted	Current cooler temperature(s)	Diaphragm pump does not work	Check voltage on terminals X2/17 and X2/8 ; OK?
		Contaminated diaphragm pump	Remove the tubes at the pump head and check; OK? Clean pump if necessary; OK?
		Sample probe/line clogged up or sample line squashed	Remove sample line at gas inlet (see 1 in Figure 13); Gas flow? Clean contaminated sample line or replace; No gas flow?
		Sample line to analyzer clogged up or squashed	Disconnect the outlet tube on the analyzer side and check whether sample gas flows at the tube fitting; No gas flow? Clean contaminated lines or replace; Gas flows?
	Liquid alarm on display: LA1	<u>Optional liquid alarm sensor:</u> Sensor turns measuring pump off automatically;	Momentary overloading of the cooler due to excessive amount of condensate; OK? Check tubes for condensate removal; OK? Check tubes of the peristaltic pump (see manual peristaltic pump SR25.2-W); OK? Check peristaltic pump SR25.2-W (see manual peristaltic pump SR25.2-W); OK? Check ECPX000C cooler instruction manual;
	Current cooler temperature(s)	<u>Optional flowmeter(s):</u> Needle valve closed.	Adjust needle valve(s) to the desired flow



Problem	Display	Possible causes	Check/Solution
Cooler and sample gas pump running; Condensate in the sample gas line	Current cooler temperature(s)	pump tube defect	Replace pump tube (see manual peristaltic pump SR25.2-W); ok?
		Peristaltic pump SR25.2-W does not work	Check peristaltic pump (see manual peristaltic pump SR25.2-W); ok?
		Not sufficient drying of sample gas	Check ECPX000C (see ECPX000C cooler instruction manual);
		Sensor has not turned off pump.	Check the LA sensor function

24 Proper disposal of the device

At the end of the service life of our products, it is important to take care of the appropriate disposal of obsolete electrical and non-electrical devices. To help protect our environment, follow the rules and regulations of your country regarding recycling and waste management.

25 Spare parts list

Wear, tear and replacement part requirements depend on specific operating conditions. The recommended quantities are based on experience and are not binding.

For spare parts of components which are not presented in the following list please see the specific instruction manuals or leaflets added in the appendix.

Portable Conditioning System PSS5C, PSS5C/2, PSS5/3					
(C) consumable parts, (R) recommended spare parts, (S) spare parts					
Part No.	Description	C/R/S	recommended quantity PSS5C... being in operation [years]		
			1	2	3
Fine filter FP-2T:					
90F0002	Filter element F-2T , PTFE, 2 µm	C	6	12	20
90F0040	Viton O-ring, 26 for FP-	R	1	1	1
90F0056	PVDF filter element clamp F-P	S	-	-	1
90F0012	Filter body F-120G of glass	R	1	1	1
Fine filter FP-2T with Option LA1S: 4 (see Figure 8)					
90F0015	Filter body F-120G-D of glass with GL 25 condensate connection thread	R	1	1	1
90F0020	Union nut GL 25	R	1	1	1
90F0025	PTFE sealing ring GL 25-12 mm Ø	R	1	1	1
Peristaltic pump SR25.2-W:					
90P1007	SR25 pump hose with PVDF tube connectors DN 4/6 mm	C	1	2	4
Diaphragm pump type N3 KPE/KP18; N5 KPE/KP18					
90P2100	Square cap type D3, 1/8" female for N3/N5 KPE/KP18 Material: PVDF	S	-	-	1
90P2120	Diaphragm type S3, for N3/N5 KPE/KP18, Material: Viton®, PTFE coated	C	1	2	3
90P2111	Valve reed type V3 with O-ring type O3, for N3-N5, 1 pc, material: Viton® (2 pieces required)	C	2	4	6
90P2105	Intermediate plate type Z3, for N3/N5 PE/KP18 Material: PVDF	S	-	-	1
Diaphragm pump type N9 KPE/KP18					
90P2200	Square cap type D9, 1/8" female for N9 KPE/KP18, Material: PVDF	S	-	-	1
90P2220	Diaphragm type S9, for N9 KPE/KP18, Material: Viton®, PTFE coated	C	1	2	3
90P2211	Valve plate with seal for N9 KPE, 1 pc., material: Viton®, (2 pcs./pump)	C	2	4	6
90P2205	Intermediate plate type Z9, for N9 KPE/KP18, Material: PVDF	S	-	-	1

Portable Conditioning System PSS5C, PSS5C/2, PSS5/3					
(C) consumable parts, (R) recommended spare parts, (S) spare parts					
Part No.	Description	C/R/S	recommended quantity PSS5C... being in operation [years]		
			1	2	3
Option flowmeter FM40:					
90A0015	Flowmeter glass for FM40 range 7-70 l/h air	S	-	1	1
94F0010	Flowmeter glass for FM40 range 15-150 l/h air	S	-	1	1
94F0015	Flowmeter glass for FM40 range 25-250 l/h air	S	-	1	1
94F0020	Flowmeter glass for FM40 range 50-500 l/h air	S	-	1	1
90A0018	Viton O-ring 9 for flowmeter glass FM40	R	2	4	6
Diverse:					
90K6030	Fine fuse 4 A T, 5 mm x 20 mm for PSS...	R	5	5	5
90G0020	Fine fuse 10 A T, 5 mm x 20 mm for PSS... with option temp. controller and heated sample line	R	5	5	5
Hose and hose fittings:					
05V3215	Bulkhead union SV-PVDF DN 4/6 PSS5 optional PVDF = Polyvinylidenfluoride	R	2	2	2
05V6600	Sealing ring 4/6 PVDF see above	R	5	10	10
05V6605	Union nut M10-4/6 PVDF see above	R	5	10	10
01T4000	Tube PVC DN 4/6 (meters)	S	3	6	9
01T1000	Tube Viton® DN 4/6 (meters)	S	1	2	3
01T2000	Tube Novoprene DN 3,2/6,4 (meters)	S	1	2	3
02B1000	Tube PTFE DN 4/6 (meters)	S	1	2	3
10T1000	Hose cutter	S	1	1	1

26 Appendix

- Circuit diagram **PSS5C**
- Table of parameter codes



More product documentation is available in our Internet catalogue:
www.mc-techgroup.com

- Instruction manual: Electric gas cooler **ECPX000C**
- Data sheet: Universal-Filters **FP, FT, FPK, FS, FSS**
- Instruction manual: **Diaphragm pump Series N**
- Instruction manual: Peristaltic pump **SR25.2-W**
- Instruction manuals: Liquid alarm sensor **LA1S** and electronic controllers type **LA1.4**
- Data sheet: Flow meter **FM40**
- Data sheet : Ball valves **L/PV-1**
- Instruction manual: Temperature controller **701**

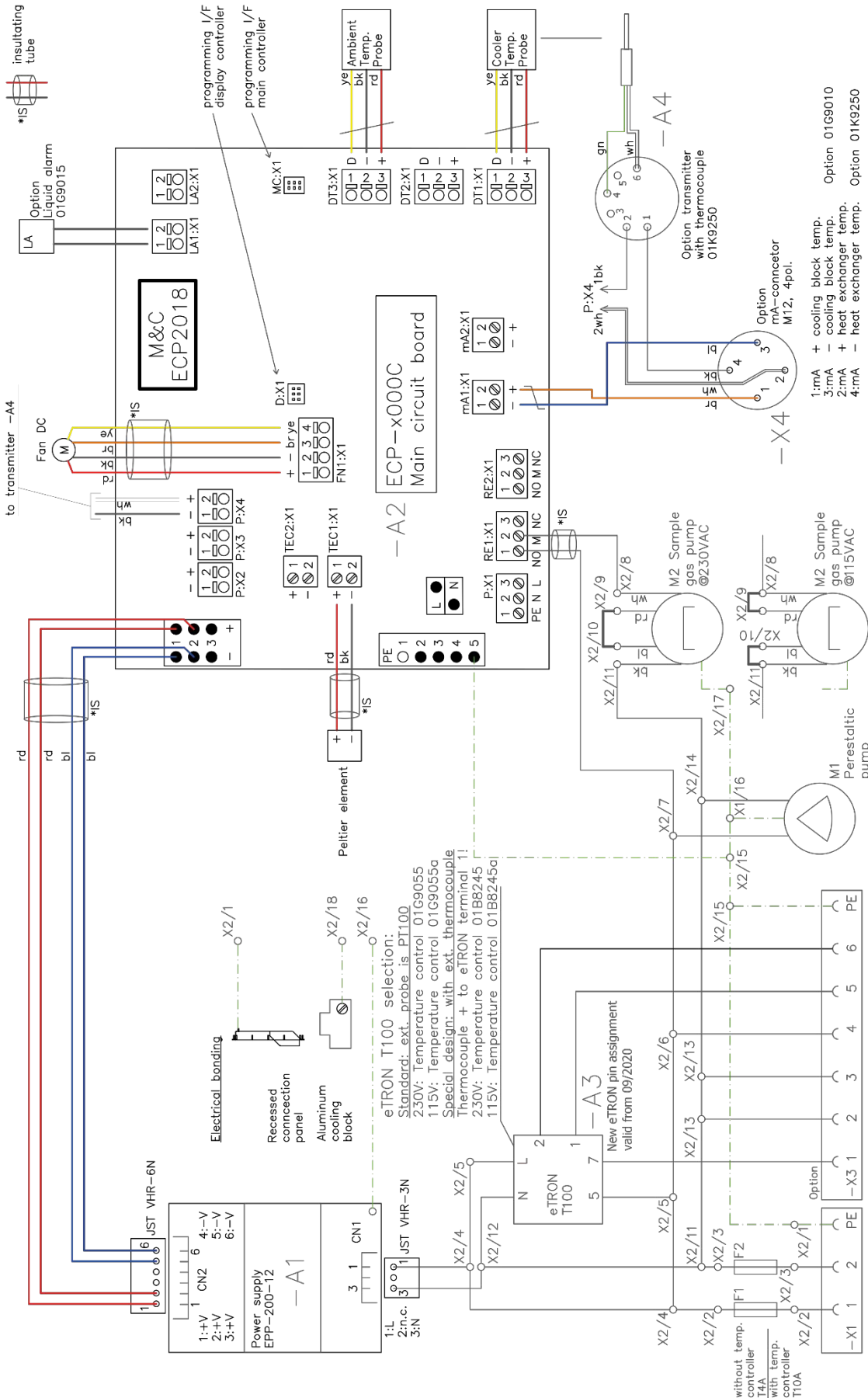









Figure 16 Circuit diagram PSS5C

Table of Parameter Codes

No.	Description:	Default:	Range:	Note:
1	Software version			
5	Brightness setting of display	5	0 - 9	Brightest display setting is 9
10	LA on/off switching	0	0, 1, 2	0=off; 1= without cable break detection; 2= with cable break detection
11	Sensitivity LA	2	1-7	The higher the value is, the sooner the alarm is triggered.
12	HIGH dT	3	2 - 8 [°C]	Differential temperature between set point and upper temperature alarm limit
13	LOW dT	3	2 - 8 [°C]	Differential temperature between setpoint and lower temperature alarm limit
14	Hysteresis (temperature alarm)	2	1, 2 [°C]	As soon as a temperature alarm limit of "2" is selected, the hysteresis is automatically reduced to 1
15	mA range selection	4-20	0-20 / 4-20 [mA]	Corresponds to the temperature range: -10 °C to +50 °C (4 – 20 mA: at 5 °C = 8 mA)
70	Operating time in days			This value will not be deleted even after restarting
84	Fan speed	1	0-5	Value has no influence on the output power
210	Calibration LA dry			Connect the sensor and confirm with the  -key.
211	Calibration LA wet			Hold the sensor in water and confirm with the  -key.
212	Calibration LA open / cable break			Disconnect the sensor and confirm with the  -key. The cable break detection triggers in the middle between this value and that of dry.
213	Display LA dry			Check here the current value
214	Display LA wet			Check here the current value
215	Display LA open			Check here the current value
310	mA output LOW Calibration	1 mA		Connect the multimeter and press or hold  or  -keys until the display matches 1 mA .
311	mA output HIGH Calibration	20 mA		Connect the multimeter and press and hold  or  -keys until the display matches 20 mA .